

# Kinetix 5700 DC-bus Power Supply

Catalog Numbers 2198-P031, 2198-P070, 2198-P141, 2198-P208

Topic	Page
About the DC-bus Power Supply	1
Important User Information	2
Catalog Number Explanation	3
Before You Begin	3
Remove the Grounding Screw in Select Power Configurations	3
Install the DC-bus Power Supply	5
Drilling Hole Patterns	6
Connector Data	9
Wiring Requirements	12
Circuit Breaker/Fuse Specifications	14
Specifications	15
Additional Resources	15

## About the DC-bus Power Supply

The Kinetix® 5700 DC-bus (converter) power supply with 400V-class three-phase AC input provides continuous output power and current to servo drives for applications with requirements in the range of 7...46 kW and 10.5...69.2 A, respectively.

See the Kinetix 5700 Servo Drives User Manual, publication [2198-UM002](#), for detailed information on wiring, applying power, troubleshooting, and integration with ControlLogix® EtherNet/IP communication modules or CompactLogix™ 5370 controllers.

## Important User Information

Read this document and the documents listed in the additional resources section about installation, configuration, and operation of this equipment before you install, configure, operate, or maintain this product. Users are required to familiarize themselves with installation and wiring instructions in addition to requirements of all applicable codes, laws, and standards.

Activities including installation, adjustments, putting into service, use, assembly, disassembly, and maintenance are required to be carried out by suitably trained personnel in accordance with applicable code of practice.

If this equipment is used in a manner not specified by the manufacturer, the protection provided by the equipment may be impaired.

In no event will Rockwell Automation, Inc. be responsible or liable for indirect or consequential damages resulting from the use or application of this equipment.

The examples and diagrams in this manual are included solely for illustrative purposes. Because of the many variables and requirements associated with any particular installation, Rockwell Automation, Inc. cannot assume responsibility or liability for actual use based on the examples and diagrams.

No patent liability is assumed by Rockwell Automation, Inc. with respect to use of information, circuits, equipment, or software described in this manual.

Reproduction of the contents of this manual, in whole or in part, without written permission of Rockwell Automation, Inc., is prohibited.

Throughout this manual, when necessary, we use notes to make you aware of safety considerations.

---



**WARNING:** Identifies information about practices or circumstances that can cause an explosion in a hazardous environment, which may lead to personal injury or death, property damage, or economic loss.

---



**ATTENTION:** Identifies information about practices or circumstances that can lead to personal injury or death, property damage, or economic loss. Attentions help you identify a hazard, avoid a hazard, and recognize the consequence.

---

### **IMPORTANT**

Identifies information that is critical for successful application and understanding of the product.

---

Labels may also be on or inside the equipment to provide specific precautions.

---



**SHOCK HAZARD:** Labels may be on or inside the equipment, for example, a drive or motor, to alert people that dangerous voltage may be present.

---



**BURN HAZARD:** Labels may be on or inside the equipment, for example, a drive or motor, to alert people that surfaces may reach dangerous temperatures.

---



**ARC FLASH HAZARD:** Labels may be on or inside the equipment, for example, a motor control center, to alert people to potential Arc Flash. Arc Flash will cause severe injury or death. Wear proper Personal Protective Equipment (PPE). Follow ALL Regulatory requirements for safe work practices and for Personal Protective Equipment (PPE).

---

## Catalog Number Explanation

This publication applies to the following Kinetix 5700 DC-bus power supplies.

### DC-bus Power Supply Catalog Numbers

DC-bus Power Supply Cat. No.	Module Width mm	Input Voltage	Continuous Output Power kW	Continuous Output Current $A_{DC}$ rms
2198-P031	55	324...528V rms, three-phase	7	10.5
2198-P070			17	25.5
2198-P141	85		31	46.9
2198-P208			46	69.2

## Before You Begin

Remove all packing material, wedges, and braces from within and around the components. After unpacking, check the item nameplate catalog number against the purchase order.

### Parts List

The DC-bus power supplies ship with the following:

- DC-bus end caps
- Wiring plug connector set for mains input power (IPD), 24V control input power (CP), digital inputs (IOD), shunt power (RC), and contactor enable (CED)
- Wiring plug connector for shunt power (RC) connections installed on the drive
- These installation instructions, publication 2198-IN009

**TIP** Replacement connector sets are also available. See the Kinetix Servo Drives Specifications Technical Data, publication [GMC-TD003](#), for more information.

## Remove the Grounding Screw in Select Power Configurations

Remove the grounding screw when using ungrounded, corner-grounded, and impedance-grounded power configurations.

---

**IMPORTANT** If you have grounded-wye power distribution, you do not need to remove the screw. Go to Install the DC-bus Power Supply on [page 5](#).  
EMC performance can be affected if you remove the grounding screw.

---

We recommend that you remove the grounding screw when the drive module is removed from the panel and placed on its side on a solid surface equipped as a grounded static-safe workstation.

---



**ATTENTION:** When you remove the grounding screw, the risk of equipment damage exists because the unit no longer maintains line-to-neutral voltage protection.

---



**ATTENTION:** To avoid personal injury, the grounding-screw access door must be kept closed when power is applied. If power was present, and then removed, wait at least 5 minutes for the DC-bus voltage to dissipate, and verify that no DC-bus voltage exists before accessing the grounding screw.

---

To access the grounding screw, open the small plastic door on the right side of the module.

### Remove the Grounding Screw

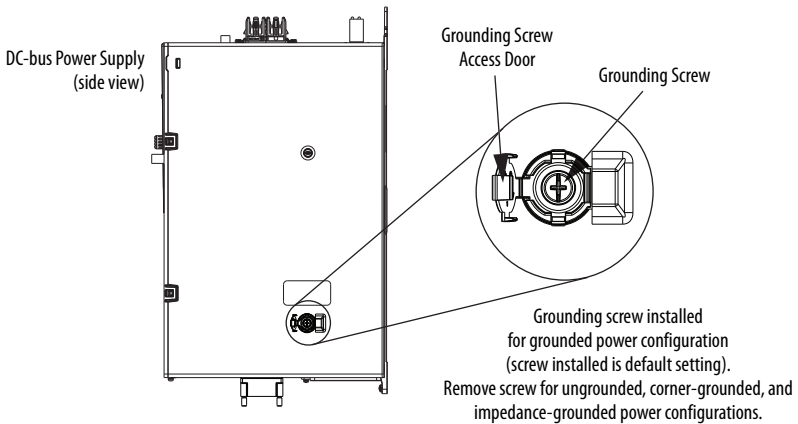

**ATTENTION:** Risk of equipment damage exists. The drive-module ground configuration must be accurately determined. Leave the grounding screw installed for grounded power configurations (default). Remove the screw for ungrounded, corner-grounded, and impedance-grounded power.

---

## Grounding Screw Configurations

Ground Configuration <sup>(1)</sup>	Grounding Screw Configuration	Benefits of Configuration
Grounded (wye)	Installed (default setting)	<ul style="list-style-type: none"> <li>• UL and EMC compliance</li> <li>• Reduced electrical noise</li> <li>• Most stable operation</li> <li>• Reduced voltage stress on components and motor bearings</li> </ul>
<ul style="list-style-type: none"> <li>• AC-fed ungrounded</li> <li>• Corner grounded</li> <li>• Impedance grounded</li> </ul>	Removed	<ul style="list-style-type: none"> <li>• Helps avoid severe equipment damage when ground fault occurs</li> <li>• Reduced leakage current</li> </ul>

(1) Refer to the Kinetix 5700 Servo Drives User Manual, publication [2198-UM002](#), for example configurations.

## Install the DC-bus Power Supply

These procedures assume that you have prepared your panel and understand how to bond your system. For installation instructions regarding equipment and accessories not included here, refer to the instructions that came with those products.



**SHOCK HAZARD:** To avoid hazard of electrical shock, perform all mounting and wiring of the Kinetix 5700 drive prior to applying power. Once power is applied, connector terminals can have voltage present even when not in use.



**ATTENTION:** Plan the installation of your system so that you can perform all cutting, drilling, tapping, and welding with the system removed from the enclosure. Because the system is of the open type construction, be careful to keep any metal debris from falling into it. Metal debris or other foreign matter can become lodged in the circuitry and result in damage to components.

## Mount the DC-bus Power Supply

Observe these clearance requirements when mounting the DC-bus power supply:

- Additional clearance is required for cables and wires or the shared-bus connection system connected to the top of the drive module.
- Additional clearance is required if other devices are installed above and/or below the drive and have clearance requirements of their own.
- Additional clearance left and right of the drive module is required when mounted adjacent to noise sensitive equipment or clean wire ways.
- The recommended minimum cabinet depth is 300 mm (11.81 in.).

## Minimum Clearance Requirements

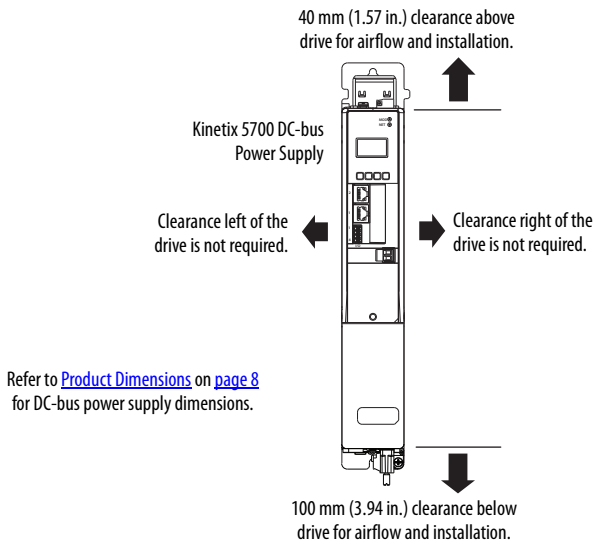

**IMPORTANT** Mount the drive module in an upright position as shown. Do not mount the drive module on its side.

The Kinetix 5700 drive system must be spaced by aligning the zero-stack tab and cutout. For mounting, sizing, and configuring shared-bus configurations, refer to the Kinetix 5700 Servo Drives User Manual, publication [2198-UM002](#).

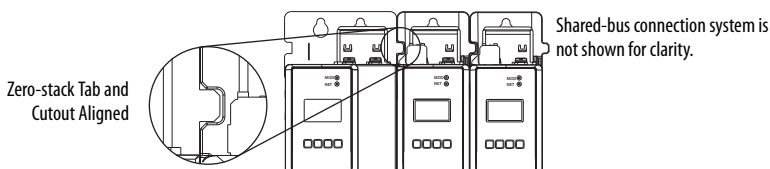

Mount the Kinetix 5700 drive module to the cabinet subpanel with M5 (#10-32) steel bolts torqued to 4.0 N•m (35.4 lb•in), max.

## Drilling Hole Patterns

This section provides hole patterns for Kinetix 5700 drive modules that are mounted in zero-stack (shared-bus) configurations:

- The DC-bus power supply is always mounted in the far left position.
- Inverter modules with a higher power rating are always mounted to the left of any inverter module with a lower power rating.

Calculate the left-to-right hole pattern for any Kinetix 5700 drive module configuration by following these steps.

1. The first hole location is zero.
2. The second hole location is module width minus 55 mm.
3. The next hole location is 55 mm.
4. Repeat step 2 and step 3 for the remaining holes.

### Kinetix 5700 Mounting Hole Patterns

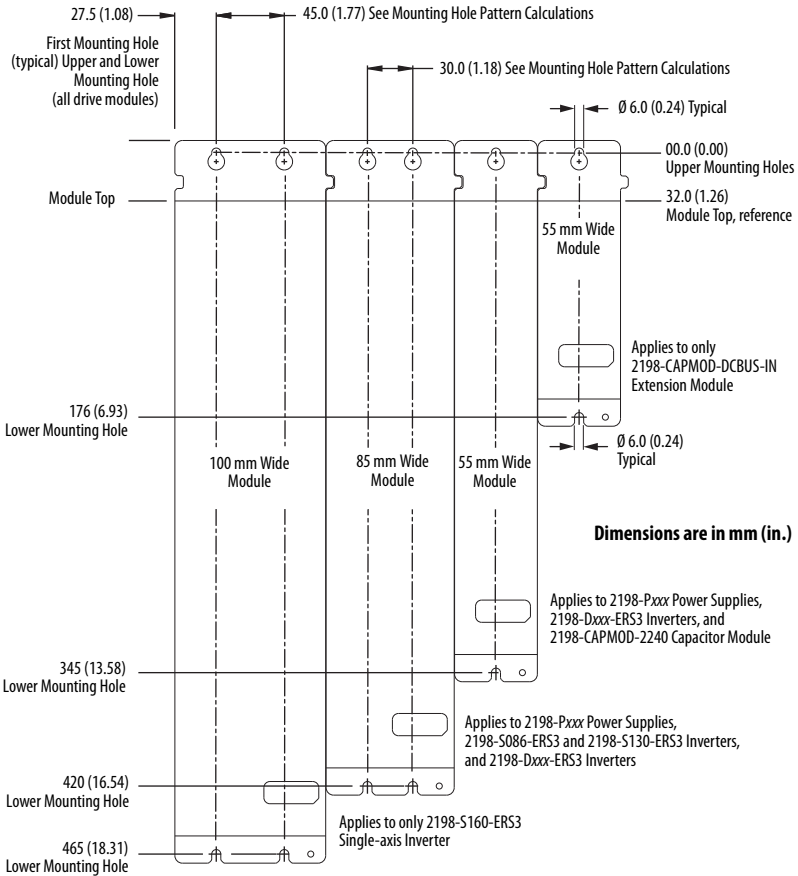

Also available to assist you with mounting holes is the Kinetix 5700 System Mounting Toolkit, catalog number 2198-K5700-MOUNTKIT.

## Product Dimensions

Refer to the Kinetix Servo Drives Technical Data, publication [GMC-RM003](#), for product dimensions of all Kinetix 5700 drive modules.

Dimensions are in mm (in.)

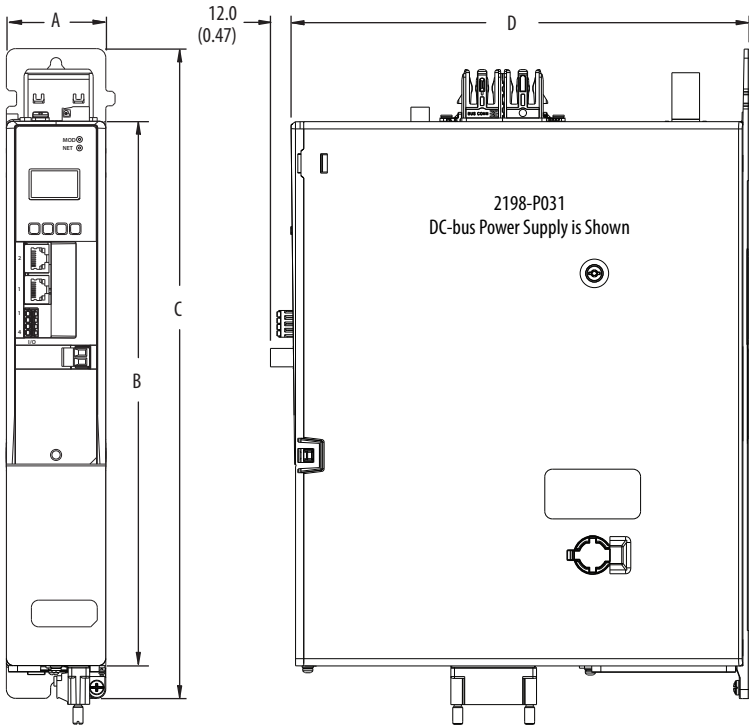

DC-bus Power Supply Cat. No.	A mm (in.)	B mm (in.)	C mm (in.)	D mm (in.)
2198-P031	55 (2.17)	300 (11.8)	358 (14.1)	252 (9.9)
2198-P070				
2198-P141	85 (3.35)	375 (14.8)	433 (17.0)	
2198-P208				



## Connector Data

Use this illustration to identify the DC-bus power supply features and indicators.

### DC-bus Power Supply Features and Indicators (2198-P031 power supply is shown)

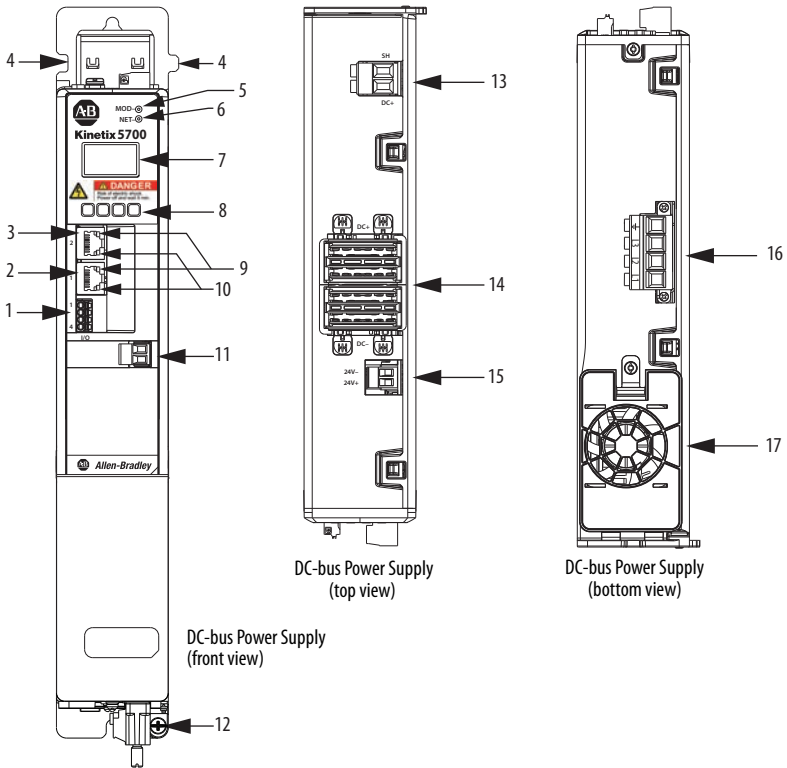

Item	Description
1	Digital inputs (IOD) connector
2	Ethernet (PORT1) RJ45 connector
3	Ethernet (PORT2) RJ45 connector
4	Zero-stack mounting tab/cutout
5	Module status indicator
6	Network status indicator



Item	Description
7	LCD display
8	Navigation push buttons
9	Link speed status indicators
10	Link/Activity status indicators
11	Contacter enable (CED) connector
12	Ground lug

Item	Description
13	Shunt resistor (RC) connector
14	DC bus (DC) connector
15	24V control input power (CP) connector
16	AC Input power (IPD) connector
17	Cooling fan

**DC-bus Power Supply Connectors**

Designator	Description	Connector
IPD	AC mains input power	4-position plug, terminal screws
DC	DC common bus power	DC-bus links and end caps
CP	24V control input power	2-position plug, terminal screws
RC	Shunt power	2-position plug, terminal screws
IOD	Digital inputs	4-position plug, spring terminals
CED	Contacteur enable	2-position plug, terminal screws
PORT1, PORT2	Ethernet communication ports	RJ45 Ethernet

**Mains Input Power (IPD) Connector Pinout**

IPD Pin	Description	Signal
	Chassis ground	
L3	Three-phase input power	L3
L2		L2
L1		L1

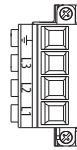

**Shunt Power (RC) Connector Pinout**

RC Pin	Description	Signal
1	Shunt connections	SH
2		DC+



**Contacteur Enable (CED) Connector Pinout**

CED Pin	Description	Signal
EN-	Contacteur-enable connections	CONT EN-
EN+		CONT EN+



The contactor-enable circuitry includes a relay-driven contact within the 2198-Pxxx DC-bus power supply. The relay protects the Kinetix 5700 drive system in the event of overloads or other fault conditions.

An AC three-phase mains contactor must be wired in series between the branch circuit protection and the DC-bus power supply. In addition, the AC three-phase contactor control string must be wired in series with the contactor-enable relay at the contactor enable (CED) connector. Refer to the Kinetix 5700 Servo Drives User Manual, publication [2198-UM002](#), for wiring examples.



**ATTENTION:** Wiring the contactor-enable relay is required. To avoid personal injury or damage to the Kinetix 5700 drive system, wire the contactor-enable relay into your control string so that:

- three-phase power is removed and the DC-bus power supply is protected under various fault conditions.
- three-phase power is never applied to the Kinetix 5700 drive system before control power is applied.

### Control Input Power (CP) Connector Pinout

CP Pin	Description	Signal
2	24V common	24V-
1	24V power supply, customer-supplied	24V+



### Digital Inputs (IOD) Connector Pinout

IOD Pin	Description	Signal
1	Digital input #1	IN1
2	I/O common for customer-supplied 24V supply.	COM
3	Digital input #2	IN2
4	I/O cable shield termination point.	SHLD

Pin 1



### Ethernet Communication PORT1 and PORT2 Pinout

Port Pin	Description	Signal
1	Transmit port (+) data terminal	+ TX
2	Transmit port (-) data terminal	- TX
3	Receive port (+) data terminal	+ RX
4	–	–
5	–	–
6	Receive port (-) data terminal	- RX
7	–	–
8	–	–

Standard RJ45

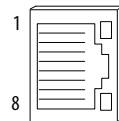



## Wiring Requirements

Wire must be copper with 75 °C (167 °F) minimum rating. Phasing of mains AC power is arbitrary and earth ground connection is required for safe and proper operation.

**IMPORTANT** The National Electrical Code and local electrical codes take precedence over the values and methods provided.

### DC-bus Power Supply Wiring Requirements

DC-bus Power Supply Cat. No.	Description	Connects to Terminals		Wire Size mm <sup>2</sup> (AWG)	Strip Length mm (in.)	Torque Value N·m (lb·in)
		Pin	Signal			
2198-P031 2198-P070	Mains input power	 L3	 L3	6...10 (10...8)	10.0 (0.39)	0.5...0.8 (4.4...7.1)
2198-P141 2198-P208		L2 L1	L2 L1	10...35 (8...2)	20.0 (0.79)	2.5...4.5 (22...40)
2198-Pxxx	PELV/SELV 24V power (connector plug)	CP-1 CP-2	24V+ 24V-	0.5...2.5 (20...14)	7.0 (0.28)	0.22...0.25 (1.9...2.2)
	DC Bus power	Bus bar	DC- DC+	N/A <sup>(1)</sup>	N/A <sup>(1)</sup>	N/A <sup>(1)</sup>
	Contactore enable	EN- EN+	CONT EN- CONT EN+	0.14...2.5 (26...12)	7.0 (0.28)	0.4...0.5 (3.5...4.4)
	Shunt resistor	RC-1 RC-2	SH DC+	1.5...6 (16...10)	12.0 (0.47)	0.5...0.6 (4.5...5.3)
	Digital inputs	IOD-1 IOD-2 IOD-3 IOD-4	IN1 COM IN2 COM	0.14...1.5 (26...16)	10.0 (0.39)	N/A <sup>(2)</sup>

(1) Shared DC-bus power connections are always made from drive to drive over the bus-bar connection system. These terminals do not receive discrete wires.

(2) This connector uses spring tension to hold wires in place.



**ATTENTION:** To avoid personal injury and/or equipment damage, observe the following:

- Make sure that installation complies with specifications regarding wire types, conductor sizes, branch circuit protection, and disconnect devices. The National Electrical Code (NEC) and local codes outline provisions for safely installing electrical equipment.
- Use motor power connectors only for connection purposes. Do not use them to turn the unit on and off.
- Ground shielded power cables to prevent potentially high voltages on the shield.

## Ground Your DC-bus Power Supply to the Subpanel

Ground Kinetix 5700 drives and Bulletin 2198 capacitor modules to a bonded-cabinet ground bus with a braided ground strap. Keep the braided ground strap as short as possible for optimum bonding.

### Connect the Braided Ground Strap

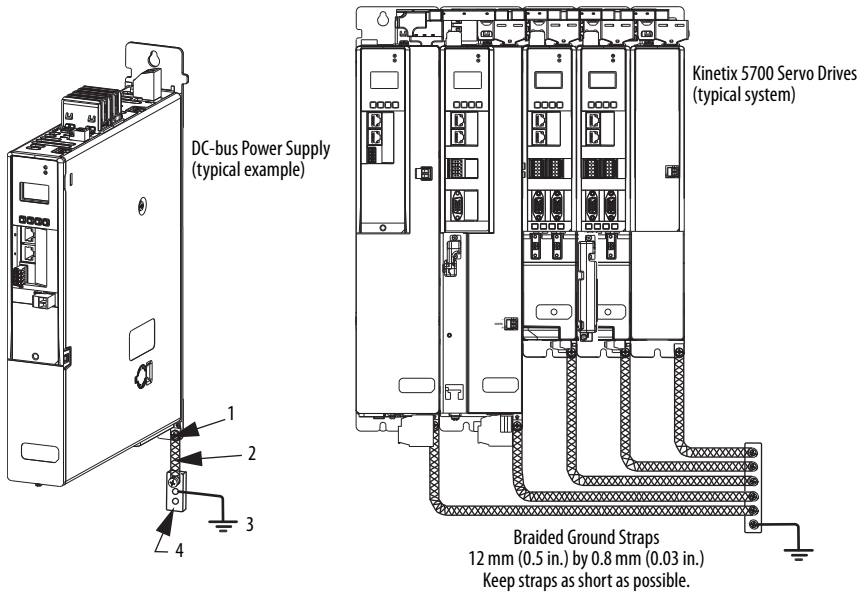

Item	Description
1	Ground screw (green) 2.0 N·m (17.5 lb-in), max
2	Braided ground strap (customer supplied)
3	Ground grid or power distribution ground
4	Bonded-cabinet ground bus (customer supplied)

### Circuit Breaker/Fuse Specifications

The Kinetix 5700 power supplies use internal solid-state motor short-circuit protection and, when protected by suitable branch circuit protection, are rated for use on a circuit that can deliver up to 200,000 A (fuses) and 65,000 A (circuit breakers). While circuit breakers offer some convenience, there are limitations for their use. Circuit breakers do not handle high-current inrush as well as fuses. Make sure that the selected components are properly coordinated and meet acceptable codes, which includes requirements for branch circuit protection. Evaluation of the short-circuit available current is critical and must be kept below the short-circuit current rating of the circuit breaker.

#### IEC (non-UL) Applications (380...415V, 50 Hz)

DC-bus Power Supply Cat. No.	Input Requirements		DIN gG Fuses, 100 kA Amps, max	Miniature CB, 15 kA Cat. No.	Motor Protection CB, 65 kA Cat. No.	Molded Case CB, 65 kA Cat. No.
	Voltage	Phases				
2198-P031			16	1489-M3D250	140M-D8E-C25	140G-66C3-C25
2198-P070	324...528V AC	Three	40	1492-SPM3D400	140M-F8E-C45	140G-66C3-C50
2198-P141			75	1492-SPM3D630	140-CMN-6300	140G-66C3-C90
2198-P208			110	–	140-CMN-9000	140G-66C3-D12

#### UL Applications (440...480V, 60 Hz)

DC-bus Power Supply Cat. No.	Input Requirements		UL Fuses, 200 kA, 600V, Class J Amps, max
	Voltage	Phases	
2198-P031			LPI-155P
2198-P070	324...528V AC	Three	LPI-40SP
2198-P141			LPI-70SP
2198-P208			LPI-100SP

## Specifications

Attribute	2198-P031	2198-P070	2198-P141	2198-P208
Surrounding air temperature Operating Storage	0...50 °C (32...122 °F) -40...70 °C (-40...158 °F)			
Weight, kg (lb) approx	4.33 (9.55)	4.42 (9.74)	6.91 (15.2)	7.04 (15.5)
Short-circuit current rating	200,000 A rms symmetrical			
Branch-circuit short-circuit protection	Integral solid-state short circuit protection does not provide branch circuit protection. Branch circuit protection must be provided in accordance with the National Electric Code (NEC) and any additional local codes.			
Leakage current	<ul style="list-style-type: none"> <li>• Kinetix 5700 drives produce leakage current in the protective-earthing conductor that exceeds 3.5 mA AC and/or 10 mA DC. The minimum size of the protective-earthing (grounding) conductor used in the application must comply with local safety regulations for high-protective-earthing conductor current equipment.</li> <li>• Kinetix 5700 drives produce DC current in the protective-earthing conductor and can reduce the ability of a residual current device (RCD) or residual current monitor (RCM) of type A or AC to provide protection for the drive module and other equipment in the installation.</li> </ul>			

## Additional Resources

These documents contain additional information concerning related products from Rockwell Automation.

Resource	Description
Kinetix 5700 Servo Drives User Manual, publication <a href="#">2198-UM002</a>	Information on installing, configuring, starting, and troubleshooting your Kinetix 5700 servo drive system.
Kinetix 5000 AC Line Filter Installation Instructions, publication <a href="#">2198-IN003</a>	Information on installing and wiring the Kinetix 5500 and Kinetix 5700 AC line filters.
Kinetix 5700 Passive Shunt Modules Installation Instructions, publication <a href="#">2198-IN011</a>	Information on installing and wiring Kinetix 5700 external shunt modules.
Kinetix Servo Drives Specifications Technical Data, publication <a href="#">GMC-TD003</a>	Provides product specifications for the Kinetix Integrated Motion over EtherNet/IP network, Integrated Motion over sercos interface, EtherNet/IP networking, and component servo drive families.
Kinetix Motion Accessories Specifications Technical Data, publication <a href="#">GMC-TD004</a>	Provides product specifications for Bulletin 2090 motor and interface cables, low-profile connector kits, drive power components, and other servo drive accessory items.
Industrial Automation Wiring and Grounding Guidelines, publication <a href="#">1770-4.1</a>	Provides general guidelines for installing a Rockwell Automation® industrial system.
Product Certifications website, <a href="http://www.ab.com">http://www.ab.com</a>	Provides declarations of conformity, certificates, and other certification details.

You can view or download publications at <http://www.rockwellautomation.com/literature>. To order paper copies of technical documentation, contact your local Allen-Bradley distributor or Rockwell Automation sales representative.

# Rockwell Automation Support

Rockwell Automation provides technical information on the Web to assist you in using its products.

At <http://www.rockwellautomation.com/support> you can find technical and application notes, sample code, and links to software service packs. You can also visit our Support Center at <https://rockwellautomation.custhelp.com/> for software updates, support chats and forums, technical information, FAQs, and to sign up for product notification updates.

In addition, we offer multiple support programs for installation, configuration, and troubleshooting. For more information, contact your local distributor or Rockwell Automation representative, or visit <http://www.rockwellautomation.com/services/online-phone>.

## Installation Assistance

If you experience a problem within the first 24 hours of installation, please review the information that's contained in this manual. You can also contact a special Customer Support number for initial help in getting your product up and running.

United States or Canada	1.440.646.3434
Outside United States or Canada	Use the <a href="#">Worldwide Locator</a> at <a href="http://www.rockwellautomation.com/rockwellautomation/support/overview.page">http://www.rockwellautomation.com/rockwellautomation/support/overview.page</a> , or contact your local Rockwell Automation representative.

## New Product Satisfaction Return

Rockwell Automation tests all of its products to help ensure that they are fully operational when shipped from the manufacturing facility. However, if your product is not functioning and needs to be returned, follow these procedures.

United States	Contact your distributor. You must provide a Customer Support case number (call the phone number above to obtain one) to your distributor to complete the return process.
Outside United States	Please contact your local Rockwell Automation representative for the return procedure.

## Documentation Feedback

Your comments will help us serve your documentation needs better. If you have any suggestions on how to improve this document, complete this form, publication [RA-DU002](#), available at <http://www.rockwellautomation.com/literature/>.

Rockwell Automation maintains current product environmental information on its website at <http://www.rockwellautomation.com/rockwellautomation/about-us/sustainability-ethics/product-environmental-compliance.page>.

Allen-Bradley, CompactLogix, ControlLogix, Kinetix, Rockwell Software, and Rockwell Automation are trademarks of Rockwell Automation, Inc. Trademarks not belonging to Rockwell Automation are property of their respective companies.

Rockwell Otomasyon Ticaret A.Ş., Kar Plaza İş Merkezi E Blok Kat:6 34752 İçerenköy, İstanbul, Tel: +90 (216) 5698400

[www.rockwellautomation.com](http://www.rockwellautomation.com)

### Power, Control and Information Solutions Headquarters

Americas: Rockwell Automation, 1201 South Second Street, Milwaukee, WI 53204-2496 USA, Tel: (1) 414.382.2000, Fax: (1) 414.382.4444  
Europe/Middle East/Africa: Rockwell Automation NV, Pegasus Park, De Kleerlaan 12a, 1831 Diegem, Belgium, Tel: (32) 2 663 0600, Fax: (32) 2 663 0640  
Asia Pacific: Rockwell Automation, Level 14, Core F, Cyberport 3, 100 Cyberport Road, Hong Kong, Tel: (852) 2887 4788, Fax: (852) 2508 1846



PN-315847

Publication 2198-IN009B-EN-P - June 2015

Supersedes Publication 2198-IN009A-EN-P - March 2015

Copyright © 2015 Rockwell Automation, Inc. All rights reserved. Printed in the U.S.A.